

LTwo® – opal – lambertian

constant voltage 48V – 20 watt/m

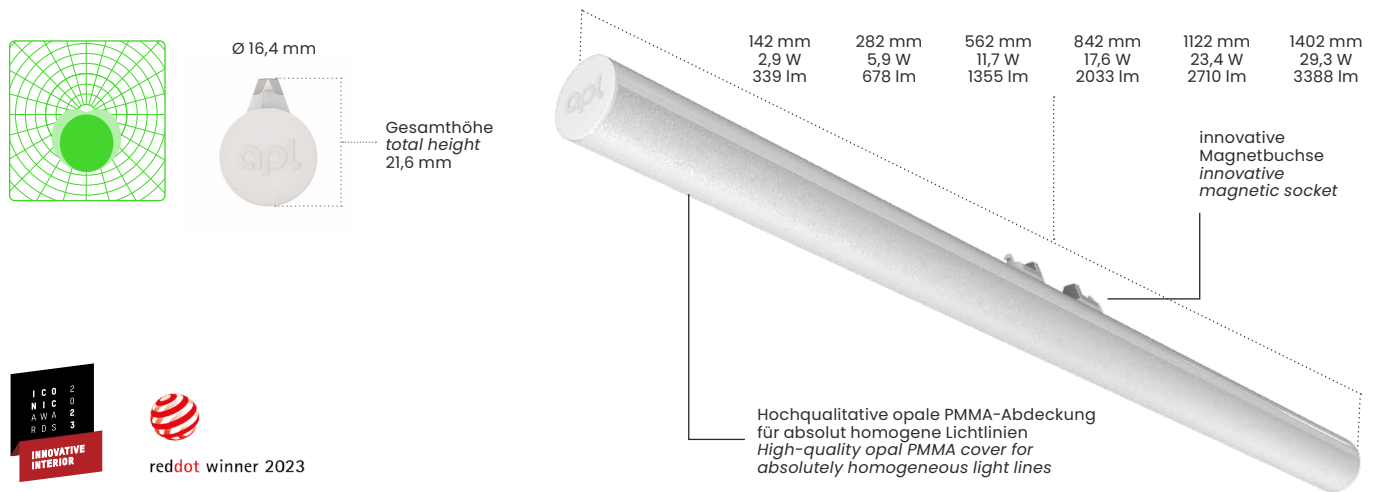

reddot winner 2023

produktbeschreibung

LTwo® – Light Tube with Optics. Hochqualitative opale Abdeckung mit max. 3.388 Lumen, basierend auf dem modularen, miniaturisierten LTwo® Lichtquellen-/Leuchtensystem mit 13 hochwertigen Präzisionsoptiken und umfangreichem Zubehör, für alle Beleuchtungsanwendungen. Mit neu entwickelter, multifunktionaler Lampen-/ Leuchtenfassung für einfache, werkzeuglose, magnetische Installation und Winkeleinstellung in +/-20°, sowie Verriegelung. Kodierter Sockel, für sicheren Betrieb von Lampen-Leuchten mit unterschiedlichen Betriebsströmen in Constant Voltage oder Constant Current. Sehr umweltfreundlich durch minimalen Materialeinsatz (180g/m), Austauschbarkeit, Recyclingfähigkeit und die hohe Effizienz (bis zu 180 lm/W).

- LTwo® opal – Lambertian – Constant Voltage 48V – 20W/m mit 16,4 mm Durchmesser
- Erhältlich in schwarz (RAL9005) und weiß (RAL9016)
- Längen: 142 mm, 282 mm, 562 mm, 842 mm, 1122 mm, 1402 mm
- Wattagen: 2,9 W; 5,9 W; 11,7 W; 17,6 W; 23,4 W; 29,3 W
- Lumen @5000K: 339 lm, 678 lm, 1355 lm, 2033 lm, 2710 lm, 3388 lm
- Optische Effizienz: 60 % (BB), 77 % (WW)
- UGR von 28,4 / 25,2 (BB), 28,4 / 25,1 (WW)
- Ideal für eine optimale und weiche Grund- und dekorative Beleuchtung
- Optimal geeignet für Gebäude und Materialintegration aller Art
- Dimmbar (PWM)
- Benötigt magnetische Lampenfassung als notwendiges Zubehör

Achtung: alle nachfolgenden optischen und elektronischen Daten haben eine Toleranz von +/- 10%.

Attention: all following optical and electronic data have a tolerance of +/- 10%.

product description

LTwo® – Light Tube with Optics. High-quality opal cover with max. 3,388 lumen, based on the modular, miniaturised LTwo® light source/luminaire system with 13 high-quality precision optics and extensive accessories, for all lighting applications. With newly developed, multifunctional lamp/luminaire holder for easy, tool-free, magnetic installation and angle adjustment in +/-20°, as well as locking. Coded socket, for safe operation of lamp luminaires with different operating currents in Constant Voltage or Constant Current. Very environmentally friendly due to minimal use of material (180g/m), interchangeability, recyclability and high efficiency (up to 180 lm/W).

- LTwo® opal – lambertian – Constant Voltage 48V – 20W/m with 16.4 mm diameter
- Available in black (RAL9005) and white (RAL9016)
- Lengths: 142 mm, 282 mm, 562 mm, 842 mm, 1122 mm, 1402 mm
- Watts: 2,9 W; 5,9 W; 11,7 W; 17,6 W; 23,4 W; 29,3 W
- Lumen @5000K: 339 lm, 678 lm, 1355 lm, 2033 lm, 2710 lm, 3388 lm
- Optical efficiency: 60 % (BB), 77 % (WW)
- UGR of 28.4 / 25.2 (BB), 28.4 / 25.1 (WW)
- Ideal for optimal and soft general and decorative lighting
- Optimally suited for buildings and material integration of all kinds
- Dimmable (PWM)
- Requires magnetic luminaire holder as necessary accessory



Siehe Legende auf der letzten Seite / legend on last page

produkteigenschaften / product features

Maße / Dimensions

16,4 mm Durchmesser / diameter

Länge / Length (mm)

142 mm, 282 mm, 562 mm, 842 mm, 1122 mm, 1402 mm

2,9W; 5,9W; 11,7W; 17,6W; 23,4W; 29,2W

339 lm, 678 lm, 1355 lm, 2033 lm, 2710 lm, 3388 lm

Qty. LED

32 per 280 mm

LED Pitch

8,75 mm

CCT / CRI

2700K, 3000K, 3500K, 4000K, 5000K (>90)

Binning

3 SDCM

Lebensdauer / Lifetime

60000h L80B10

Schutzklasse / Protection

class IP20 (nur für Innenräume! / indoor use only!)

Risikogruppe / Risk group

RG1

Betriebsart / Operating Mode

Constant Voltage (CV)

Betriebsspannung / Operating Voltage

48 V DC -2,0 / +1,75

Gehäusetemp / Housing temperatur (Tc)

min. -20° / max. +70°

Umgebungstemperatur / Ambient temperature (Ta)

min. -20° / max. +35°

Lagertemperatur / Storage temperatur (Ts)

min. -20° / max. 85°

bestellcode / order code

Bitte tragen Sie hier den Code ein / Please enter code here:

Product	OP	NP	Optic	L	PC	C	LH	IP
APL LTwo®T5	CV	20	OP				MAG	IP20
APL LTwo®T5	CV	20	OP	140	927	BB	MAG	IP20
				280	930	WW		
				560	935			
				840	940			
				1120	950			
				1400				

beispiel bestellcode / example order code

APL LTwo®T5 CV 20 OP 280 927 BB MAG IP20

OP Betriebssystem / operating system	CV Konstantspannung / Constant Voltage
NP Normleistung pro m / nominal power per m	BB schwarzes Profil – schwarze Entblendung / black profile – black antiglare
Optic Optik / optics	WW weißes Profil – weiße Entblendung / white profile – white antiglare
L Länge / length	MAG magnetische Lampenfassung / magnetic luminaire holder
PC Photometrischer Code* / photometric code*	
C Gehäusefarbe / housing colour	
LH Lampenfassung / luminaire holder	
IP Schutzart / protection class	

*Photometrischer Code Beispiel / photometric code example:
927 (9 = CRI >90 | 27 = 2700K)

LTwo® – opal – lambertian constant voltage 48V – 20 W/m

White Black

CRI / CCT	Kelvin	140 mm 2,9 W	280 mm 5,9 W	560 mm 11,7 W	840 mm 17,6 W	1120 mm 23,4 W	1400 mm 29,3 W	Lumen/Watt
927	2700K	302	604	1209	1813	2418	3022	103,3
		236	471	942	1413	1884	2355	80,5
930	3000K	313	626	1251	1877	2503	3128	106,9
		244	488	975	1463	1950	2438	83,3
935	3500K	323	647	1294	1940	2587	3234	110,6
		252	504	1008	1512	2016	2520	86,2
940	4000K	334	668	1336	2004	2672	3340	114,2
		260	521	1041	1562	2082	2603	89,0
950	5000K	339	678	1355	2033	2710	3388	115,8
		264	528	1056	1584	2112	2640	90,3

lichtverteilung / light distribution

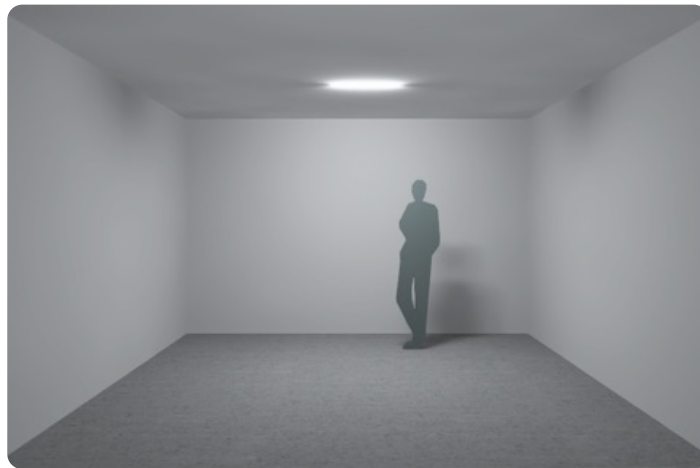
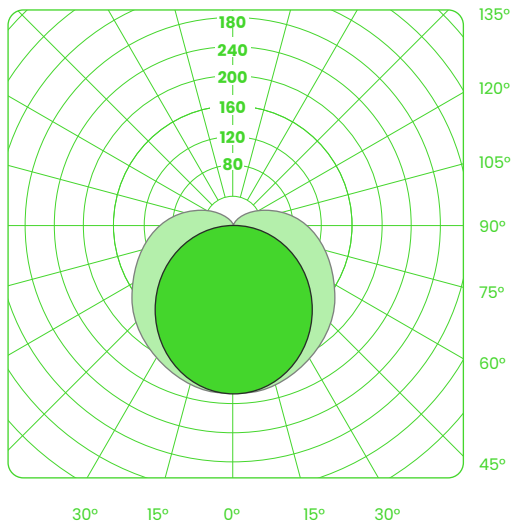

LTwo® schwarz / black – opal, 560mm

c0/c180 c90/c270

notwendiges zubehör / necessary accessories



- Weiß / White
MS-T5-C1-7A (W-9016)
10449
- Schwarz / Black
MS-T5-C1-7A (B-9005)
10450

**LTwo® magnetische Lampenfassung
PIT-Block 3-polig – Constant Voltage 48V**
zur Aufnahme 3-poliger Kabel
für den elektrischen Anschluss an externe PSU

**LTwo® magnetic luminaire holder
PIT-block 3-pole – Constant Voltage 48V**
to accommodate 3-pole cables
for electrical connection to external PSU



- Weiß / White
MS-T5-C1-1A (W-9016)
10451
- Schwarz / Black
MS-T5-C1-1A (B-9005)
10452

**LTwo® magnetische Lampenfassung
JST 3-polig – Constant Voltage 48V**
zur Aufnahme des 3-poligen Kabelsatzes mit
JST-Stecker und offenen Kabelenden
(CA-CV-324-30E-B-1 (100cm))
für den elektrischen Anschluss an externe PSU

**LTwo® magnetic luminaire holder
JST 3-pole – Constant Voltage 48V**
to accommodate the 3-pole cable set with
JST-connector and open cable ends
(CA-CV-324-30E-B-1 (100cm))
for electrical connection to external PSU



- Schwarz / Black
CA-CV-324-30E-B-1 (100 cm)
10457

**3-poliger Kabelsatz mit JST-Stecker für
LTwo® magnetische Lampenfassung
Constant Voltage – 1m**
zur einfachen Verbindung der LTwo® magnetischen
Lampenfassung mit externer PSU

**3-pole cable set with JST-connector for
LTwo® magnetic luminaire holder
Constant Voltage – 1m**
for easy connection of the LTwo® magnetic
luminaire holder with external PSU

montagezubehör / mounting accessories



- Weiß / White
MH-T5-EE-1D (W-9016)
10460
- Schwarz / Black
MH-T5-EE-1D (B-9005)
10459

Rechteckige Montagehalterung
für LTwo® magnetische Lampenfassung
zur vorderseitigen Montage

Rectangular mounting bracket
for LTwo® magnetic luminaire holder
for front mounting



- Weiß / White
MH-T5-ER-1D (W-9016)
10462
- Schwarz / Black
MH-T5-ER-1D (B-9005)
10461

Runde Montagehalterung
für LTwo® magnetische Lampenfassung
zur vorderseitigen Montage

Round mounting bracket
for LTwo® magnetic luminaire holder
for front mounting

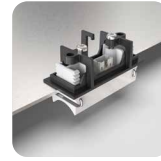

- Schwarz / Black
MH-T5-SR-1C (B-9005)
10463

Rückseitige Montagehalterung
zum Verschrauben
für LTwo® magnetische Lampenfassung

Rear mounting bracket
for screwing
for LTwo® magnetic luminaire holder



- Schwarz / Black
MH-T5-RA-1C (B-9005)
10493

Rückseitige Montagehalterung
zum Verrasten
für LTwo® magnetische Lampenfassung

Rear mounting bracket
to snap in
for LTwo® magnetic luminaire holder



- Weiß / White
MH-T5-UD-2F (W-9016)
10466
- Schwarz / Black
MH-T5-UD-2F (B-9005)
10465

Unterputzdosen-Montagehalterung
für LTwo® magnetische Lampenfassung

Flush-box mounting bracket
for LTwo® magnetic luminaire holder



- Weiß / White
MH-T5-HI-1D (W-9016)
10468
- Schwarz / Black
MH-T5-HI-1D (B-9005)
10467

Gehäuse mit Innengewinde
für LTwo® magnetische Lampenfassung
(Zubehör zur Abpendelung und für Stromschienen)

Housing with internal thread
for LTwo® magnetic luminaire holder
(accessories for suspension and track)



- Weiß / White
MH-T5-W1-1 (W-9016)
10471
- Schwarz / Black
MH-T5-W1-1 (B-9005)
10469

90° Winkel-Adapter
für LTwo® magnetische Lampenfassung

90° angle adapter
for LTwo® magnetic luminaire holder

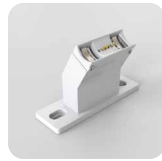

- Weiß / White
MH-T5-W2-1A (W-9016)
10472
- Schwarz / Black
MH-T5-W2-1A (B-9005)
10470

30° Winkel-Adapter (Museumswinkel)
für LTwo® magnetische Lampenfassung

30° angle adapter (museum angle)
for LTwo® magnetic luminaire holder

konstantspannung led-treiber / constant voltage led power supply units

Hier finden Sie eine kleine Auswahl an Konstantspannung LED-Treibern, die wir für LTwo® Konstantspannung Produkte anbieten und empfehlen.

Here you will find a small selection of Constant Voltage LED power supply units that we offer and recommend for LTwo® Constant Voltage products.



KGP

□
LV100W48CG
10443



- 350 x 30 x 18 mm
- schaltbar
- 48 V, 0–100,8
- bis zu 92 % Effizienz
- nominale Lebensdauer bis zu 50.000h
- Netzspannung 220–240 V
- Eingangsfrequenz 50–60 Hz
- Leistungsfaktor ≥ 0.95
- Restwelligkeit 0,5 %
- Schutzart IP20



KGP

□
LV150W48CG
10444



- 350 x 30 x 18mm
- schaltbar
- 48V, 0–150 W
- bis zu 92 % Effizienz
- nominale Lebensdauer bis zu 50.000h
- Netzspannung 220–240 V
- Eingangsfrequenz 50–60 Hz
- Leistungsfaktor ≥ 0.95
- Restwelligkeit 0.5 %
- Schutzart IP20



KGP

□
LV100W48CG 1-10
10445



- 350 x 30 x 18mm
- dimmbar
- 1–10V
- 48V, 0–100 W
- bis zu 92 % Effizienz
- nominale Lebensdauer bis zu 50.000h
- Netzspannung 220 – 240 V
- Eingangsfrequenz 50–60 Hz
- Leistungsfaktor ≥ 0.95
- Restwelligkeit 0,5 %
- Schutzart IP20



- 350 x 30 x 18mm
- switchable;
- 48 V, 0–100,8
- up to 92 % Efficiency
- Lifetime 50.000h
- Input Voltage 220–240 V
- Frequency 50–60 Hz
- Power Factor ≥ 0.95 ; Current
- Ripple 0,5 %
- Protection class IP20



- 350 x 30 x 18mm
- switchable
- 48V, 0–150 W
- up to 92 % Efficiency
- Lifetime 50.000h
- Input Voltage 220–240 V
- Frequency 50–60 Hz
- Power Factor ≥ 0.95
- Current Ripple 0.5 %
- Protection class IP20



- 350 x 30 x 18mm
- dimmable
- 1–10V
- 48V, 0–100 W
- up to 92 % Efficiency
- Lifetime 50.000h
- Input Voltage 220–240 V
- Frequency 50–60 Hz
- Power Factor ≥ 0.95
- Current Ripple 0,5 %
- Protection class IP20



KGP

□
LV150W48CG 1-10
10446



- 350 x 30 x 18mm
- dimmbar ; 1–10 V
- 48 V, 0–150 W
- bis zu 92 % Effizienz
- nominale Lebensdauer bis zu 50.000h
- Netzspannung 220–240 V
- Eingangsfrequenz 50–60 Hz
- Leistungsfaktor ≥ 0.95
- Restwelligkeit 0,5 %
- Schutzart IP20



TRIDONIC

□
LC100W 48V one4all NF ip EXC
10447



- 225 x 43 x 30 mm
- Dimmbar
- 48 V, 0–100 W
- bis zu 93 % Effizienz
- Zum Leuchteneinbau oder als unabhängiger LED-Treiber verwendbar
- One4all Interface ermöglicht verschiedene Dimmmöglichkeiten
- Dimmbereich von 1–100 %

- Kein externer Dimmer notwendig
- Nominale Lebensdauer bis zu 100.000 h
- Netzspannung 220–240 V
- Eingangsfrequenz 50–60 Hz
- Schutzart IP20



- 350 x 30 x 18mm
- dimmable ; 1–10V
- 48V, 0–150 W
- up to 92 % Efficiency
- Lifetime 50.000h
- Input Voltage 220–240V
- Frequency 50–60 Hz
- Power Factor ≥ 0.95
- Current Ripple 0,5 %
- Protection class IP20



- 225 x 43 x 30 mm
- dimmable
- 48 V, 0–100 W
- Up to 93 % Efficiency
- Can be either used built-in or independent
- One4all interface enables different dimming options
- Dimming range 1 to 100 %



- No additional external dimmer is needed
- Nominal lifetime up to 100,000 h
- Input Voltage 220–240 V
- Frequency 50–60 Hz
- Protection class IP20

icon legende / icon legend



Lichtverteilung Light distribution

-  10° HB Narrow spot
Narrow spot
-  13° Spot
Spot
-  25° Narrow flood
Narrow flood
-  40° Flood
Flood
-  60° Wide flood
Wide flood
-  90° Extra wide flood
Extra wide flood
-  BWN Batwing narrow
Batwing narrow
-  BWW Batwing wide
Batwing wide
-  WW Wallwash
Wallwash
-  CL Klare Abdeckung
Clear cover
-  DF Diffuse Abdeckung
Diffuse cover
-  OP Opale Abdeckung
Opal cover
-  OVAL Ovale Abdeckung
Oval cover

Abstrahlrichtung Beam direction

-  Direkt
Direct
-  Indirekt
Indirect
-  Direkt / Indirekt
Direct / Indirect











Betriebsart Operation modes

-  CV Konstantspannung
Constant voltage
-  48V 48 Volt
48 Volt
-  12W 12 Watt
12 Watt
-  20W 20 Watt
20 Watt
-  CC Konstantstrom
Constant current
-  300 mA 300 mA
300 mA
-  600 mA 600 mA
600 mA







Schutzklassen Protection class

-  IP20 Schutzklasse
Protection class
-  IP54 Schutzklasse
Protection class
-  IP67 Schutzklasse
Protection class
-  Innenbereich
Indoor
-  Schutzklasse 1
Protection class 1
-  Schutzklasse 2
Protection class 2
-  Schutzklasse 3
Protection class 3
-  SELV Zusätzliche Sicherheit /
Niederspannung
Extra safety /
low voltage

Lichtqualität light quality

-  2700 K Farbtemperatur
Color temperature
-  3000 K Farbtemperatur
Color temperature
-  3500 K Farbtemperatur
Color temperature
-  4000 K Farbtemperatur
Color temperature
-  5000 K Farbtemperatur
Color temperature
-  CRI >80 Farbwiedergabeindex
Color rendering index
-  CRI >90 Farbwiedergabeindex
Color rendering index
-  60 kh Lebensdauer
Lifetime
-  L80 B10 Lebensdauer
Lifetime
-  LM 80 LM80 konform
LM80 compliant
-  UGR <16 Blendungsbewertung
Unified glare rating

Montageart Mounting type

-  Anbau Decke
Ceiling
-  Anbau Boden
Floor
-  Einbau Decke
Recessed ceiling
-  Einbau Boden
Recessed floor
-  Pendel
Pendant
-  Anbau Wand
Wall

icon legende / icon legend

Steuerung Control

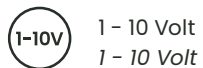

1 – 10 Volt
1 – 10 Volt



DALI
DALI



Dimmbar
Dimmable

Zertifikate Certificates

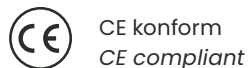

CE konform
CE compliant

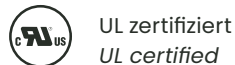

UL zertifiziert
UL certified



DIN konform
DIN compliant

Sonstiges Others

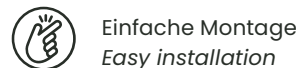

Einfache Montage
Easy installation



Weiss
White



Schwarz
Black

Fassung luminaire holder



Magnetisch
Magnetic

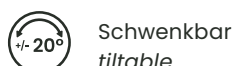

Schwenkbar
tiltable



Sicherheitsbügel
Safety bracket