

LTwo® – 10°HB – narrow spot

constant voltage 48V – 12 watt/m

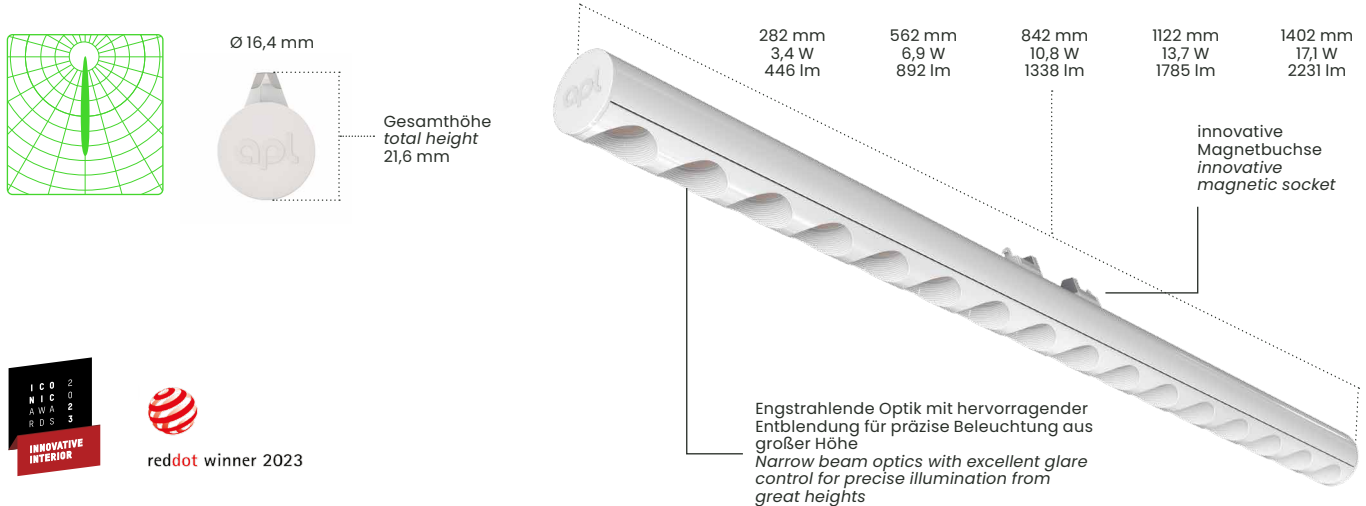

produktbeschreibung

LTwo® – Light Tube with Optics. Engstrahlende 10°HB Optik mit max. 2.231 Lumen, basierend auf dem modularen, miniaturisierten LTwo® Lichtquellen-/Leuchtensystem mit 13 hochwertigen Präzisionsoptiken und umfangreichem Zubehör, für alle Beleuchtungsanwendungen. Mit neu entwickelter, multifunktionaler Lampen-/ Leuchtenfassung für einfache, werkzeuglose, magnetische Installation und Winkeleinstellung in +/-20°, sowie Verriegelung. Kodierter Sockel, für sicheren Betrieb von Lampen-Leuchten mit unterschiedlichen Betriebsströmen in Constant Voltage oder Constant Current. Sehr umweltfreundlich durch minimalen Materialeinsatz (180g/m), Austauschbarkeit, Recyclingfähigkeit und die hohe Effizienz (bis zu 180 lm/W).

- LTwo® 10°HB – narrow spot – Constant Voltage 48V – 12W/m mit 16,4 mm Durchmesser
- Erhältlich in schwarz (RAL9005) und weiß (RAL9016)
- Längen: 282 mm, 562 mm, 842 mm, 1122 mm, 1402 mm
- Wattagen: 3,4 W; 6,9 W; 10,8 W; 13,7 W; 17,1 W
- Lumen @5000K: 446 lm, 892 lm, 1.338 lm, 1.785 lm, 2.231 lm
- Optische Effizienz: 79 % (BB), 83 % (WW)
- UGR von -2,8 / -5,8 (BB), 10,2 / 11,0 (WW) @1.000lm
- Ideal für präzise Punktbeleuchtung aus großer Höhe
- Optimal geeignet für Gebäude und Materialintegration aller Art
- Dimmbar (PWM)
- Benötigt magnetische Lampenfassung als notwendiges Zubehör

product description

LTwo® – Light Tube with Optics. Narrow spot 10°HB optics with max. 2,231 lumen, based on the modular, miniaturised LTwo® light source/luminaire system with 13 high-quality precision optics and extensive accessories, for all lighting applications. With newly developed, multifunctional lamp/luminaire holder for easy, tool-free, magnetic installation and angle adjustment in +/-20°, as well as locking. Coded socket, for safe operation of lamp luminaires with different operating currents in Constant Voltage or Constant Current. Very environmentally friendly due to minimal use of material (180g/m), interchangeability, recyclability and high efficiency (up to 180 lm/W).

- LTwo® 10°HB – narrow spot – Constant Voltage 48V – 12W/m with 16.4 mm diameter
- Available in black (RAL9005) and white (RAL9016)
- Lengths: 282 mm, 562 mm, 842 mm, 1122 mm, 1402 mm
- Watts: 3,4 W; 6,9 W; 10,8 W; 13,7 W; 17,1 W
- Lumen @5000K: 446 lm, 892 lm, 1,338 lm, 1,785 lm, 2,231 lm
- Optical efficiency: 79 % (BB), 83 % (WW)
- UGR of -2.8 / -5.8 (BB), 10.2 / 11.0 (WW) @1,000lm
- Ideal for precise spot lighting from great heights
- Optimally suited for buildings and material integration of all kinds
- Dimmable (PWM)
- Requires magnetic luminaire holder as necessary accessory

Achtung: alle nachfolgenden optischen und elektronischen Daten haben eine Toleranz von +/- 10%.

Attention: all following optical and electronic data have a tolerance of +/- 10%.



Siehe Legende auf der letzten Seite / legend on the last page

produkteigenschaften / product features

Maße / Dimensions

16,4 mm Durchmesser / diameter

Länge / Length (mm)

282 mm, 562 mm, 842 mm, 1122 mm, 1402 mm
3,4W; 6,9W; 10,8W; 13,7W; 17,1W
446 lm, 892 lm, 1338 lm, 1785 lm, 2231 lm

Qty. LED

16 per 280 mm

LED Pitch

17,5 mm

CCT / CRI

2700K, 3000K, 3500K, 4000K (>90) 5000K (>80)

Binning

3 SDCM

Lebensdauer / Lifetime

60000h L80B10

Schutzklasse / Protection

class IP20 (nur für Innenräume! / indoor use only!)

Risikogruppe / Risk group

RG1

Betriebsart / Operating Mode

Constant Voltage (CV)

Betriebsspannung / Operating Voltage

48 V DC -2,0 / +1,75

Gehäusetemp / Housing temperatur (Tc)

min. -20° / max. +65°

Umgebungstemperatur / Ambient temperature (Ta)

min. -20° / max. +45°

Lagertemperatur / Storage temperatur (Ts)

min. -20° / max. 85°

bestellcode / order code

Bitte tragen Sie hier den Code ein / Please enter code here:

Product	OP	NP	Optic	L	PC	C	LH	IP
APL LTwo®T5	CV	12	10				MAG	IP20
APL LTwo®T5	CV	12	10	280	927	BB	MAG	IP20
				560	930	WW		
				840	935			
				1120	940			
				1400	850			

beispiel bestellcode / example order code

APL LTwo®T5 CV 12 10 280 927 BB MAG IP20

OP Betriebssystem / operating system	CV Konstantspannung / Constant Voltage
NP Normleistung pro m / nominal power per m	BB schwarzes Profil – schwarze Entblendung / black profile – black antiglare
Optic Optik / optics	WW weißes Profil – weiße Entblendung / white profile – white antiglare
L Länge / length	MAG magnetische Lampenfassung / magnetic luminaire holder
PC Photometrischer Code* / photometric code*	
C Gehäusefarbe / housing colour	
LH Lampenfassung / luminaire holder	
IP Schutzart / protection class	

*Photometrischer Code Beispiel / photometric code example:
927 (9 = CRI >90 | 27 = 2700K)

LTwo® – 10°HB – narrow spot constant voltage 48V – 12 W/m

White Black

CRI/CCT	Kelvin	280 mm 3,4 W	560 mm 6,9 W	840 mm 10,8 W	1120 mm 13,7 W	1400 mm 17,1 W	Lumen/Watt
927	2700K	344	689	1033	1378	1722	100,6
		328	656	984	1311	1639	95,7
930	3000K	374	747	1121	1494	1868	109,1
		356	711	1067	1422	1778	103,8
935	3500K	355	710	1064	1419	1774	103,6
		338	675	1013	1351	1689	98,6
940	4000K	374	747	1121	1494	1868	109,1
		356	711	1067	1422	1778	103,8
850	5000K	446	892	1338	1785	2231	130,3
		425	849	1274	1699	2123	124,0

lichtverteilung / light distribution

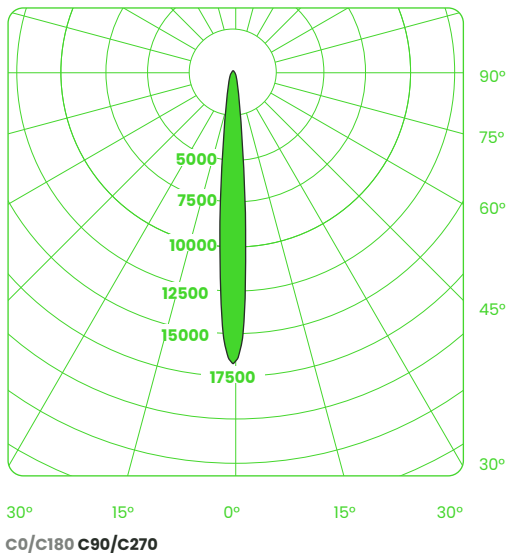

LTwo® schwarz / black - 10°HB, 560mm

notwendiges zubehör / necessary accessories



- Weiß / White
MS-T5-C1-7A (W-9016)
10449
- Schwarz / Black
MS-T5-C1-7A (B-9005)
10450

**LTwo® magnetische Lampenfassung
PIT-Block 3-polig – Constant Voltage 48V**
zur Aufnahme 3-poliger Kabel
für den elektrischen Anschluss an externe PSU

**LTwo® magnetic luminaire holder
PIT-block 3-pole – Constant Voltage 48V**
to accommodate 3-pole cables
for electrical connection to external PSU



- Weiß / White
MS-T5-C1-1A (W-9016)
10451
- Schwarz / Black
MS-T5-C1-1A (B-9005)
10452

**LTwo® magnetische Lampenfassung
JST 3-polig – Constant Voltage 48V**
zur Aufnahme des 3-poligen Kabelsatzes mit
JST-Stecker und offenen Kabelenden
(CA-CV-324-30E-B-1 (100cm))
für den elektrischen Anschluss an externe PSU

**LTwo® magnetic luminaire holder
JST 3-pole – Constant Voltage 48V**
to accommodate the 3-pole cable set with
JST-connector and open cable ends
(CA-CV-324-30E-B-1 (100cm))
for electrical connection to external PSU



- Schwarz / Black
CA-CV-324-30E-B-1 (100 cm)
10457

**3-poliger Kabelsatz mit JST-Stecker für
LTwo® magnetische Lampenfassung
Constant Voltage – 1m**
zur einfachen Verbindung der LTwo® magnetischen
Lampenfassung mit externer PSU

**3-pole cable set with JST-connector for
LTwo® magnetic luminaire holder
Constant Voltage – 1m**
for easy connection of the LTwo® magnetic
luminaire holder with external PSU

montagezubehör / mounting accessories



- Weiß / White
MH-T5-EE-1D (W-9016)
10460
- Schwarz / Black
MH-T5-EE-1D (B-9005)
10459

Rechteckige Montagehalterung
für LTwo® magnetische Lampenfassung
zur vorderseitigen Montage

Rectangular mounting bracket
for LTwo® magnetic luminaire holder
for front mounting



- Weiß / White
MH-T5-ER-1D (W-9016)
10462
- Schwarz / Black
MH-T5-ER-1D (B-9005)
10461

Runde Montagehalterung
für LTwo® magnetische Lampenfassung
zur vorderseitigen Montage

Round mounting bracket
for LTwo® magnetic luminaire holder
for front mounting

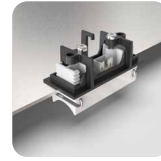

- Schwarz / Black
MH-T5-SR-1C (B-9005)
10463

Rückseitige Montagehalterung
zum Verschrauben
für LTwo® magnetische Lampenfassung

Rear mounting bracket
for screwing
for LTwo® magnetic luminaire holder



- Schwarz / Black
MH-T5-RA-1C (B-9005)
10493

Rückseitige Montagehalterung
zum Verrasten
für LTwo® magnetische Lampenfassung

Rear mounting bracket
to snap in
for LTwo® magnetic luminaire holder



- Weiß / White
MH-T5-UD-2F (W-9016)
10466
- Schwarz / Black
MH-T5-UD-2F (B-9005)
10465

Unterputzdosen-Montagehalterung
für LTwo® magnetische Lampenfassung

Flush-box mounting bracket
for LTwo® magnetic luminaire holder



- Weiß / White
MH-T5-HI-1D (W-9016)
10468
- Schwarz / Black
MH-T5-HI-1D (B-9005)
10467

Gehäuse mit Innengewinde
für LTwo® magnetische Lampenfassung
(Zubehör zur Abpendelung und für Stromschienen)

Housing with internal thread
for LTwo® magnetic luminaire holder
(accessories for suspension and track)



- Weiß / White
MH-T5-W1-1 (W-9016)
10471
- Schwarz / Black
MH-T5-W1-1 (B-9005)
10469

90° Winkel-Adapter
für LTwo® magnetische Lampenfassung

90° angle adapter
for LTwo® magnetic luminaire holder

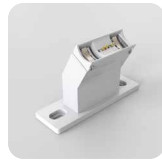

- Weiß / White
MH-T5-W2-1A (W-9016)
10472
- Schwarz / Black
MH-T5-W2-1A (B-9005)
10470

30° Winkel-Adapter (Museumswinkel)
für LTwo® magnetische Lampenfassung

30° angle adapter (museum angle)
for LTwo® magnetic luminaire holder

konstantspannung led-treiber / constant voltage led power supply units

Hier finden Sie eine kleine Auswahl an Konstantspannung LED-Treibern, die wir für LTwo® Konstantspannung Produkte anbieten und empfehlen.

Here you will find a small selection of Constant Voltage LED power supply units that we offer and recommend for LTwo® Constant Voltage products.



KGP

□
LV100W48CG
10443



- 350 x 30 x 18 mm
- schaltbar
- 48 V, 0–100,8
- bis zu 92 % Effizienz
- nominale Lebensdauer bis zu 50.000h
- Netzspannung 220–240 V
- Eingangsfrequenz 50–60 Hz
- Leistungsfaktor ≥ 0.95
- Restwelligkeit 0,5 %
- Schutzart IP20



KGP

□
LV150W48CG
10444



- 350 x 30 x 18mm
- schaltbar
- 48V, 0–150 W
- bis zu 92 % Effizienz
- nominale Lebensdauer bis zu 50.000h
- Netzspannung 220–240 V
- Eingangsfrequenz 50–60 Hz
- Leistungsfaktor ≥ 0.95
- Restwelligkeit 0,5 %
- Schutzart IP20



KGP

□
LV100W48CG 1-10
10445



- 350 x 30 x 18mm
- dimmbar
- 1–10V
- 48V, 0–100 W
- bis zu 92 % Effizienz
- nominale Lebensdauer bis zu 50.000h
- Netzspannung 220 – 240 V
- Eingangsfrequenz 50–60 Hz
- Leistungsfaktor ≥ 0.95
- Restwelligkeit 0,5 %
- Schutzart IP20



- 350 x 30 x 18mm
- switchable;
- 48 V, 0–100,8
- up to 92 % Efficiency
- Lifetime 50.000h
- Input Voltage 220–240 V
- Frequency 50–60 Hz
- Power Factor ≥ 0.95 ; Current
- Ripple 0,5 %
- Protection class IP20



- 350 x 30 x 18mm
- switchable
- 48V, 0–150 W
- up to 92 % Efficiency
- Lifetime 50.000h
- Input Voltage 220–240 V
- Frequency 50–60 Hz
- Power Factor ≥ 0.95
- Current Ripple 0.5 %
- Protection class IP20



- 350 x 30 x 18mm
- dimmable
- 1–10V
- 48V, 0–100 W
- up to 92 % Efficiency
- Lifetime 50.000h
- Input Voltage 220–240 V
- Frequency 50–60 Hz
- Power Factor ≥ 0.95
- Current Ripple 0,5 %
- Protection class IP20



KGP

□
LV150W48CG 1-10
10446



- 350 x 30 x 18mm
- dimmbar ; 1–10 V
- 48 V, 0–150 W
- bis zu 92 % Effizienz
- nominale Lebensdauer bis zu 50.000h
- Netzspannung 220–240 V
- Eingangsfrequenz 50–60 Hz
- Leistungsfaktor ≥ 0.95
- Restwelligkeit 0,5 %
- Schutzart IP20



TRIDONIC

□
LC100W 48V one4all NF ip EXC
10447



- 225 x 43 x 30 mm
- Dimmbar
- 48 V, 0–100 W
- bis zu 93 % Effizienz
- Zum Leuchteneinbau oder als unabhängiger LED-Treiber verwendbar
- One4all Interface ermöglicht verschiedene Dimmmöglichkeiten
- Dimmbereich von 1–100 %
- Kein externer Dimmer notwendig
- Nominale Lebensdauer bis zu 100.000 h
- Netzspannung 220–240 V
- Eingangsfrequenz 50–60 Hz
- Schutzart IP20



- 350 x 30 x 18mm
- dimmable ; 1–10V
- 48V, 0–150 W
- up to 92 % Efficiency
- Lifetime 50.000h
- Input Voltage 220–240V
- Frequency 50–60 Hz
- Power Factor ≥ 0.95
- Current Ripple 0,5 %
- Protection class IP20





- 225 x 43 x 30 mm
- dimmable
- 48 V, 0–100 W
- Up to 93 % Efficiency
- Can be either used built-in or independent
- One4all interface enables different dimming options
- Dimming range 1 to 100 %
- No additional external dimmer is needed
- Nominal lifetime up to 100,000 h
- Input Voltage 220–240 V
- Frequency 50–60 Hz
- Protection class IP20

icon legende / icon legend



Lichtverteilung Light distribution

-  10° HB Narrow spot
Narrow spot
-  13° Spot
Spot
-  25° Narrow flood
Narrow flood
-  40° Flood
Flood
-  60° Wide flood
Wide flood
-  90° Extra wide flood
Extra wide flood
-  BWN Batwing narrow
Batwing narrow
-  BWW Batwing wide
Batwing wide
-  WW Wallwash
Wallwash
-  CL Klare Abdeckung
Clear cover
-  DF Diffuse Abdeckung
Diffuse cover
-  OP Opale Abdeckung
Opal cover
-  OVAL Ovale Abdeckung
Oval cover

Abstrahlrichtung Beam direction

-  Direkt
Direct
-  Indirekt
Indirect
-  Direkt / Indirekt
Direct / Indirect











Betriebsart Operation modes

-  CV Konstantspannung
Constant voltage
-  48V 48 Volt
48 Volt
-  12W 12 Watt
12 Watt
-  20W 20 Watt
20 Watt
-  CC Konstantstrom
Constant current
-  300 mA 300 mA
300 mA
-  600 mA 600 mA
600 mA







Schutzklassen Protection class

-  IP20 Schutzklasse
Protection class
-  IP54 Schutzklasse
Protection class
-  IP67 Schutzklasse
Protection class
-  Innenbereich
Indoor
-  Schutzklasse 1
Protection class 1
-  Schutzklasse 2
Protection class 2
-  Schutzklasse 3
Protection class 3
-  SELV Zusätzliche Sicherheit /
Niederspannung
Extra safety /
low voltage

Lichtqualität light quality

-  2700 K Farbtemperatur
Color temperature
-  3000 K Farbtemperatur
Color temperature
-  3500 K Farbtemperatur
Color temperature
-  4000 K Farbtemperatur
Color temperature
-  5000 K Farbtemperatur
Color temperature
-  CRI >80 Farbwiedergabeindex
Color rendering index
-  CRI >90 Farbwiedergabeindex
Color rendering index
-  60 kh Lebensdauer
Lifetime
-  L80 B10 Lebensdauer
Lifetime
-  LM 80 LM80 konform
LM80 compliant
-  UGR <16 Blendungsbewertung
Unified glare rating

Montageart Mounting type

-  Anbau Decke
Ceiling
-  Anbau Boden
Floor
-  Einbau Decke
Recessed ceiling
-  Einbau Boden
Recessed floor
-  Pendel
Pendant
-  Anbau Wand
Wall

icon legende / icon legend

Steuerung Control

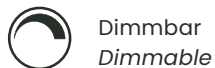
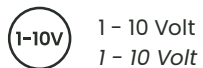

Zertifikate Certificates

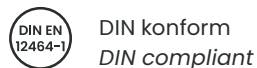
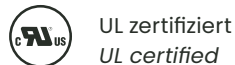

Sonstiges Others

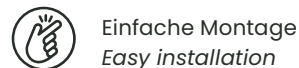

Fassung luminaire holder

