

# LTwo® – 10°HB – narrow spot

## constant voltage 48V – 20 watt/m

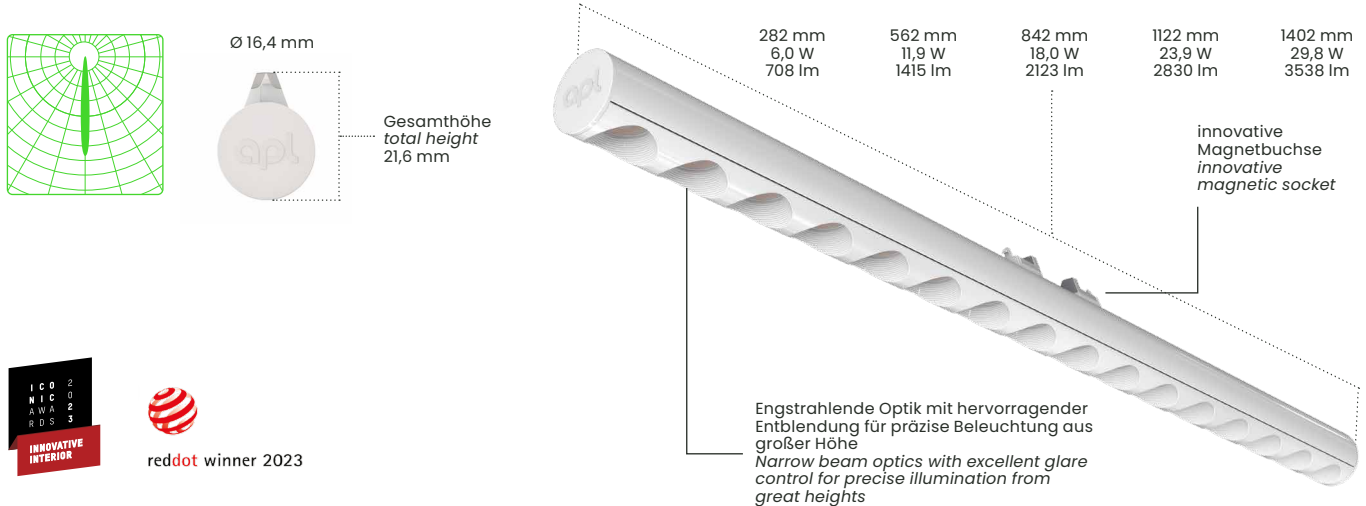

## produktbeschreibung

LTwo® – Light Tube with Optics. Engstrahlende 10°HB Optik mit max. 3.538 Lumen, basierend auf dem modularen, miniaturisierten LTwo® Lichtquellen-/Leuchtensystem mit 13 hochwertigen Präzisionsoptiken und umfangreichem Zubehör, für alle Beleuchtungsanwendungen. Mit neu entwickelter, multifunktionaler Lampen-/ Leuchtenfassung für einfache, werkzeuglose, magnetische Installation und Winkeleinstellung in +/-20°, sowie Verriegelung. Kodierter Sockel, für sicheren Betrieb von Lampen-Leuchten mit unterschiedlichen Betriebsströmen in Constant Voltage oder Constant Current. Sehr umweltfreundlich durch minimalen Materialeinsatz (180g/m), Austauschbarkeit, Recyclingfähigkeit und die hohe Effizienz (bis zu 180 lm/W).

- LTwo® 10°HB – narrow spot – Constant Voltage 48V – 20W/m mit 16,4 mm Durchmesser
- Erhältlich in schwarz (RAL9005) und weiß (RAL9016)
- Längen: 282 mm, 562 mm, 842 mm, 1122 mm, 1402 mm
- Wattagen: 6,0 W; 11,9 W; 18,0 W; 23,9 W; 29,8 W
- Lumen @5000K: 708 lm, 1.415 lm, 2.123 lm, 2.830 lm, 3.538 lm
- Optische Effizienz: 79 % (BB), 83 % (WW)
- UGR von -2,9 / -5,9 (BB), 10,1 / 10,9 (WW) @1.000lm
- Ideal für präzise Punktbeleuchtung aus großer Höhe
- Optimal geeignet für Gebäude und Materialintegration aller Art
- Dimmbar (PWM)
- Benötigt magnetische Lampenfassung als notwendiges Zubehör

## product description

LTwo® – Light Tube with Optics. Narrow spot 10°HB optics with max. 3,538 lumen, based on the modular, miniaturised LTwo® light source/luminaire system with 13 high-quality precision optics and extensive accessories, for all lighting applications. With newly developed, multifunctional lamp/luminaire holder for easy, tool-free, magnetic installation and angle adjustment in +/-20°, as well as locking. Coded socket, for safe operation of lamp luminaires with different operating currents in Constant Voltage or Constant Current. Very environmentally friendly due to minimal use of material (180g/m), interchangeability, recyclability and high efficiency (up to 180 lm/W).

- LTwo® 10°HB – narrow spot – Constant Voltage 48V – 20W/m with 16.4 mm diameter
- Available in black (RAL9005) and white (RAL9016)
- Lengths: 282 mm, 562 mm, 842 mm, 1122 mm, 1402 mm
- Watts: 6,0 W; 11,9 W; 18,0 W; 23,9 W; 29,8 W
- Lumen @5000K: 708 lm, 1,415 lm, 2,123 lm, 2,830 lm, 3,538 lm
- Optical efficiency: 79 % (BB), 83 % (WW)
- UGR of -2.9 / 5.9 (BB), 10.1 / 10.9 (WW) @1,000lm
- Ideal for precise spot lighting from great heights
- Optimally suited for buildings and material integration of all kinds
- Dimmable (PWM)
- Requires magnetic luminaire holder as necessary accessory

**Achtung:** alle nachfolgenden optischen und elektronischen Daten haben eine Toleranz von +/- 10%.

**Attention:** all following optical and electronic data have a tolerance of +/- 10%.



Siehe Legende auf der letzten Seite / legend on the last page

## produkteigenschaften / product features

### Maße / Dimensions

16,4 mm Durchmesser / diameter

### Länge / Length (mm)

282 mm, 562 mm, 842 mm, 1122 mm, 1402 mm

6,0W; 11,9W; 18,0W; 23,9W; 29,8W

708 lm, 1415 lm, 2123 lm, 2830 lm, 3538 lm

### Qty. LED

16 per 280 mm

### LED Pitch

17,5 mm

### CCT / CRI

2700K, 3000K, 3500K, 4000K (>90) 5000K (>80)

### Binning

3 SDCM

### Lebensdauer / Lifetime

60000h L80B10

### Schutzklasse / Protection

class IP20 (nur für Innenräume! / indoor use only!)

### Risikogruppe / Risk group

RG1

### Betriebsart / Operating Mode

Constant Voltage (CV)

### Betriebsspannung / Operating Voltage

48 V DC -2,0 / +1,75

### Gehäusetemp / Housing temperatur (Tc)

min. -20° / max. +70°

### Umgebungstemperatur / Ambient temperature (Ta)

min. -20° / max. +35°

### Lagertemperatur / Storage temperatur (Ts)

min. -20° / max. 85°

## bestellcode / order code

Bitte tragen Sie hier den Code ein / Please enter code here:

Product	OP	NP	Optic	L	PC	C	LH	IP
APL LTwo®T5	CV	20	10				MAG	IP20
APL LTwo®T5	CV	20	10	280	927	BB	MAG	IP20
				560	930	WW		
				840	935			
				1120	940			
				1400	850			

### beispiel bestellcode / example order code

APL LTwo®T5 CV 20 10 280 927 BB MAG IP20

<b>OP</b> Betriebssystem / operating system	<b>CV</b> Konstantspannung / Constant Voltage
<b>NP</b> Normleistung pro m / nominal power per m	<b>BB</b> schwarzes Profil – schwarze Entblendung / black profile – black antiglare
<b>Optic</b> Optik / optics	<b>WW</b> weißes Profil – weiße Entblendung / white profile – white antiglare
<b>L</b> Länge / length	<b>MAG</b> magnetische Lampenfassung / magnetic luminaire holder
<b>PC</b> Photometrischer Code* / photometric code*	
<b>C</b> Gehäusefarbe / housing colour	
<b>LH</b> Lampenfassung / luminaire holder	
<b>IP</b> Schutzart / protection class	

\*Photometrischer Code Beispiel / photometric code example:  
927 (9 = CRI >90 | 27 = 2700K)

# LTwo® – 10°HB – narrow spot constant voltage 48V – 20 W/m

White Black

CRI/CCT	Kelvin	280 mm 6,0 W	560 mm 11,9 W	840 mm 17,9 W	1120 mm 23,9 W	1400 mm 29,8 W	Lumen/Watt
927	2700K	548	1096	1643	2191	2739	91,8
		521	1043	1564	2086	2607	87,4
930	3000K	593	1185	1778	2370	2963	99,3
		564	1128	1692	2256	2820	94,6
935	3500K	564	1129	1693	2258	2822	94,6
		537	1074	1612	2149	2686	90,1
940	4000K	589	1179	1768	2357	2947	98,8
		561	1122	1683	2244	2805	94,0
850	5000K	708	1415	2123	2830	3538	118,6
		673	1347	2020	2694	3367	112,9

## lichtverteilung / light distribution

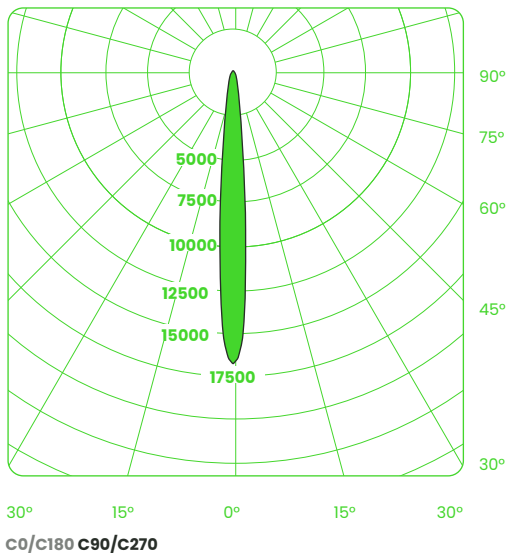

LTwo® schwarz / black - 10°HB, 560mm

## notwendiges zubehör / necessary accessories



- Weiß / White  
**MS-T5-C1-7A (W-9016)**  
10449
- Schwarz / Black  
**MS-T5-C1-7A (B-9005)**  
10450

**LTwo® magnetische Lampenfassung  
PIT-Block 3-polig – Constant Voltage 48V**  
zur Aufnahme 3-poliger Kabel  
für den elektrischen Anschluss an externe PSU

**LTwo® magnetic luminaire holder  
PIT-block 3-pole – Constant Voltage 48V**  
to accommodate 3-pole cables  
for electrical connection to external PSU



- Weiß / White  
**MS-T5-C1-1A (W-9016)**  
10451
- Schwarz / Black  
**MS-T5-C1-1A (B-9005)**  
10452

**LTwo® magnetische Lampenfassung  
JST 3-polig – Constant Voltage 48V**  
zur Aufnahme des 3-poligen Kabelsatzes mit  
JST-Stecker und offenen Kabelenden  
(CA-CV-324-30E-B-1 (100cm))  
für den elektrischen Anschluss an externe PSU

**LTwo® magnetic luminaire holder  
JST 3-pole – Constant Voltage 48V**  
to accommodate the 3-pole cable set with  
JST-connector and open cable ends  
(CA-CV-324-30E-B-1 (100cm))  
for electrical connection to external PSU



- Schwarz / Black  
**CA-CV-324-30E-B-1 (100 cm)**  
10457

**3-poliger Kabelsatz mit JST-Stecker für  
LTwo® magnetische Lampenfassung  
Constant Voltage – 1m**  
zur einfachen Verbindung der LTwo® magnetischen  
Lampenfassung mit externer PSU

**3-pole cable set with JST-connector for  
LTwo® magnetic luminaire holder  
Constant Voltage – 1m**  
for easy connection of the LTwo® magnetic  
luminaire holder with external PSU

## montagezubehör / mounting accessories



- Weiß / White  
**MH-T5-EE-1D (W-9016)**  
10460
- Schwarz / Black  
**MH-T5-EE-1D (B-9005)**  
10459

**Rechteckige Montagehalterung**  
für LTwo® magnetische Lampenfassung  
zur vorderseitigen Montage

**Rectangular mounting bracket**  
for LTwo® magnetic luminaire holder  
for front mounting



- Weiß / White  
**MH-T5-ER-1D (W-9016)**  
10462
- Schwarz / Black  
**MH-T5-ER-1D (B-9005)**  
10461

**Runde Montagehalterung**  
für LTwo® magnetische Lampenfassung  
zur vorderseitigen Montage

**Round mounting bracket**  
for LTwo® magnetic luminaire holder  
for front mounting

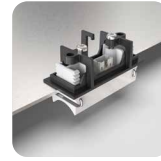

- Schwarz / Black  
**MH-T5-SR-1C (B-9005)**  
10463

**Rückseitige Montagehalterung**  
zum Verschrauben  
für LTwo® magnetische Lampenfassung

**Rear mounting bracket**  
for screwing  
for LTwo® magnetic luminaire holder



- Schwarz / Black  
**MH-T5-RA-1C (B-9005)**  
10493

**Rückseitige Montagehalterung**  
zum Verrasten  
für LTwo® magnetische Lampenfassung

**Rear mounting bracket**  
to snap in  
for LTwo® magnetic luminaire holder



- Weiß / White  
**MH-T5-UD-2F (W-9016)**  
10466
- Schwarz / Black  
**MH-T5-UD-2F (B-9005)**  
10465

**Unterputzdosen-Montagehalterung**  
für LTwo® magnetische Lampenfassung

**Flush-box mounting bracket**  
for LTwo® magnetic luminaire holder



- Weiß / White  
**MH-T5-HI-1D (W-9016)**  
10468
- Schwarz / Black  
**MH-T5-HI-1D (B-9005)**  
10467

**Gehäuse mit Innengewinde**  
für LTwo® magnetische Lampenfassung  
(Zubehör zur Abpendelung und für Stromschienen)

**Housing with internal thread**  
for LTwo® magnetic luminaire holder  
(accessories for suspension and track)



- Weiß / White  
**MH-T5-W1-1 (W-9016)**  
10471
- Schwarz / Black  
**MH-T5-W1-1 (B-9005)**  
10469

**90° Winkel-Adapter**  
für LTwo® magnetische Lampenfassung

**90° angle adapter**  
for LTwo® magnetic luminaire holder



- Weiß / White  
**MH-T5-W2-1A (W-9016)**  
10472
- Schwarz / Black  
**MH-T5-W2-1A (B-9005)**  
10470

**30° Winkel-Adapter (Museumswinkel)**  
für LTwo® magnetische Lampenfassung

**30° angle adapter (museum angle)**  
for LTwo® magnetic luminaire holder

# konstantspannung led-treiber / constant voltage led power supply units

Hier finden Sie eine kleine Auswahl an Konstantspannung LED-Treibern, die wir für LTwo® Konstantspannung Produkte anbieten und empfehlen.

Here you will find a small selection of Constant Voltage LED power supply units that we offer and recommend for LTwo® Constant Voltage products.



**KGP**

□  
**LV100W48CG**  
10443



- 350 x 30 x 18 mm
- schaltbar
- 48 V, 0–100,8
- bis zu 92 % Effizienz
- nominale Lebensdauer bis zu 50.000h
- Netzspannung 220–240 V
- Eingangsfrequenz 50–60 Hz
- Leistungsfaktor  $\geq 0.95$
- Restwelligkeit 0,5 %
- Schutzart IP20



**KGP**

□  
**LV150W48CG**  
10444



- 350 x 30 x 18mm
- schaltbar
- 48V, 0–150 W
- bis zu 92 % Effizienz
- nominale Lebensdauer bis zu 50.000h
- Netzspannung 220–240 V
- Eingangsfrequenz 50–60 Hz
- Leistungsfaktor  $\geq 0.95$
- Restwelligkeit 0.5 %
- Schutzart IP20



**KGP**

□  
**LV100W48CG 1-10**  
10445



- 350 x 30 x 18mm
- dimmbar
- 1–10V
- 48V, 0–100 W
- bis zu 92 % Effizienz
- nominale Lebensdauer bis zu 50.000h
- Netzspannung 220 – 240 V
- Eingangsfrequenz 50–60 Hz
- Leistungsfaktor  $\geq 0.95$
- Restwelligkeit 0,5 %
- Schutzart IP20



- 350 x 30 x 18mm
- switchable;
- 48 V, 0–100,8
- up to 92 % Efficiency
- Lifetime 50.000h
- Input Voltage 220–240 V
- Frequency 50–60 Hz
- Power Factor  $\geq 0.95$ ; Current
- Ripple 0,5 %
- Protection class IP20



- 350 x 30 x 18mm
- switchable
- 48V, 0–150 W
- up to 92 % Efficiency
- Lifetime 50.000h
- Input Voltage 220–240 V
- Frequency 50–60 Hz
- Power Factor  $\geq 0.95$
- Current Ripple 0.5 %
- Protection class IP20



- 350 x 30 x 18mm
- dimmable
- 1–10V
- 48V, 0–100 W
- up to 92 % Efficiency
- Lifetime 50.000h
- Input Voltage 220–240 V
- Frequency 50–60 Hz
- Power Factor  $\geq 0.95$
- Current Ripple 0,5 %
- Protection class IP20



**KGP**

□  
**LV150W48CG 1-10**  
10446



- 350 x 30 x 18mm
- dimmbar ; 1–10 V
- 48 V, 0–150 W
- bis zu 92 % Effizienz
- nominale Lebensdauer bis zu 50.000h
- Netzspannung 220–240 V
- Eingangsfrequenz 50–60 Hz
- Leistungsfaktor  $\geq 0.95$
- Restwelligkeit 0,5 %
- Schutzart IP20



**TRIDONIC**

□  
**LC100W 48V one4all NF ip EXC**  
10447



- 225 x 43 x 30 mm
- Dimmbar
- 48 V, 0–100 W
- bis zu 93 % Effizienz
- Zum Leuchteneinbau oder als unabhängiger LED-Treiber verwendbar
- One4all Interface ermöglicht verschiedene Dimmmöglichkeiten
- Dimmbereich von 1–100 %

- Kein externer Dimmer notwendig
- Nominale Lebensdauer bis zu 100.000 h
- Netzspannung 220–240 V
- Eingangsfrequenz 50–60 Hz
- Schutzart IP20



- 350 x 30 x 18mm
- dimmable ; 1–10V
- 48V, 0–150 W
- up to 92 % Efficiency
- Lifetime 50.000h
- Input Voltage 220–240V
- Frequency 50–60 Hz
- Power Factor  $\geq 0.95$
- Current Ripple 0,5 %
- Protection class IP20



- 225 x 43 x 30 mm
- dimmable
- 48 V, 0–100 W
- Up to 93 % Efficiency
- Can be either used built-in or independent
- One4all interface enables different dimming options
- Dimming range 1 to 100 %



- No additional external dimmer is needed
- Nominal lifetime up to 100,000 h
- Input Voltage 220–240 V
- Frequency 50–60 Hz
- Protection class IP20

## icon legende / icon legend





### Lichtverteilung Light distribution

-  Narrow spot  
Narrow spot
-  Spot  
Spot
-  Narrow flood  
Narrow flood
-  Flood  
Flood
-  Wide flood  
Wide flood
-  Extra wide flood  
Extra wide flood
-  Batwing narrow  
Batwing narrow
-  Batwing wide  
Batwing wide
-  Wallwash  
Wallwash
-  Klare Abdeckung  
Clear cover
-  Diffuse Abdeckung  
Diffuse cover
-  Opale Abdeckung  
Opal cover
-  Ovale Abdeckung  
Oval cover

### Abstrahlrichtung Beam direction

-  Direkt  
Direct
-  Indirekt  
Indirect
-  Direkt / Indirekt  
Direct / Indirect











### Betriebsart Operation modes

-  Konstantspannung  
Constant voltage
-  48 Volt  
48 Volt
-  12 Watt  
12 Watt
-  20 Watt  
20 Watt
-  Konstantstrom  
Constant current
-  300 mA  
300 mA
-  600 mA  
600 mA







### Schutzklassen Protection class

-  Schutzklasse  
Protection class
-  Schutzklasse  
Protection class
-  Schutzklasse  
Protection class
-  Innenbereich  
Indoor
-  Schutzklasse 1  
Protection class 1
-  Schutzklasse 2  
Protection class 2
-  Schutzklasse 3  
Protection class 3
-  Zusätzliche Sicherheit /  
Niederspannung  
Extra safety /  
low voltage

### Lichtqualität light quality

-  Farbtemperatur  
Color temperature
-  Farbtemperatur  
Color temperature
-  Farbtemperatur  
Color temperature
-  Farbtemperatur  
Color temperature
-  Farbtemperatur  
Color temperature
-  Farbwiedergabeindex  
Color rendering index
-  Farbwiedergabeindex  
Color rendering index
-  Lebensdauer  
Lifetime
-  Lebensdauer  
Lifetime
-  LM80 konform  
LM80 compliant
-  Blendungsbewertung  
Unified glare rating

### Montageart Mounting type

-  Anbau Decke  
Ceiling
-  Anbau Boden  
Floor
-  Einbau Decke  
Recessed ceiling
-  Einbau Boden  
Recessed floor
-  Pendel  
Pendant
-  Anbau Wand  
Wall

## icon legende / icon legend

### Steuerung Control

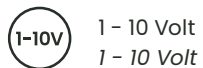

### Zertifikate Certificates

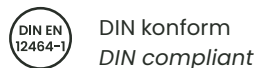
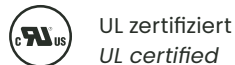
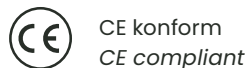

### Sonstiges Others

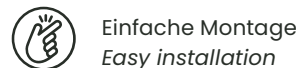

### Fassung luminaire holder

